

Multi-Rate Modular Bypass Switch, supporting up to 8 network links for failsafe connectivity of inline security appliances.



The 3296 Bypass switch supports up to 8 bypass segments in four modules. Users can mix and match network links, depending on their network deployment needs.

| Network Links* | Type | Segments per Module | Connectors |
|----------------------|-------------------------------|---------------------|------------|
| 10/100/1000M | Copper | 2 | RJ45 |
| 1, 10, 25, 40, 100Gb | Single Mode LX, LR, LR4 | 2 | LC |
| 1, 10, 25, 40, 100Gb | Multimode, SX, SR BiDi, SWDM4 | 2 | LC |
| 40, 100Gb | Multimode SR4 | 1 | MPO |
| 10Gb | Copper | 2 | RJ45 |

*Network links and Appliance interfaces are matching

BypassP2 Segment

A full bypass segment comprises two network and two appliance ports. The network ports and the appliance ports offer direct single mode (SM), multimode (MM) or copper connectivity, depending on the module.

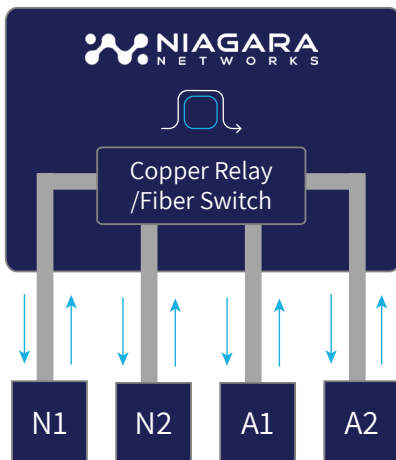

Product Highlights

High Density

- Up to 8 full bypass segments. Each bypass segment includes two network ports and two appliance ports
- 4 field replaceable modules

Bypass mode:

- Power failure
- Configurable fail-open fail-close per segment
- Configurable external Heartbeat countdown timer per segment
- Latching high performance optical switch

Multirate Network Links:

- Copper, fiber multimode BiDi and fiber singlemode
- Supports SX, SR, SR4, LX, LR, LR4
- Network links from 10Mb to 100Gb

Management:

- Multifunctional USB Type B interface
- USB API

Form Factor:

- 1U Rack mount
- Fanless for higher reliability

Low power consumption:

- USB Type B

USB For Efficient Power and Heartbeat Control

The 3296 is equipped with a USB Type B connector port. This is used for powering the unit and all of its modules, to configure segment state in case of failure and external heartbeat count-down timer for each segment. The programmable heartbeat connection is used for automatic link-loss detection. Both the chassis power and heartbeat link are controlled through a single USB port connection to the intended appliance (no separate power supply is required).

Normal Inline Mode

In normal inline mode, the common network deployment for inline security devices such as firewalls and intrusion prevention systems, traffic from one side of the network is forwarded to the inline appliance, and through the inline appliance to the other side of the network.

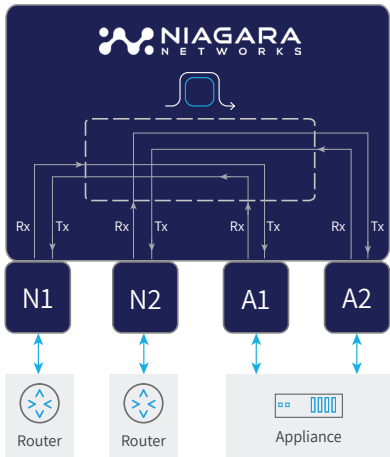

Bypass Mode.

In case of power failure, i.e no USB connectivity, the bypass segment goes from normal mode to bypass mode. Each segment can be individually configured as fail-open or fail close. On the fiber modules, the appliance ports (A1/A2) are disconnected from each other when the module is in bypass state (as depicted).

On the copper modules, the appliance ports (A1/A2) will also go into bypass when the network ports go into bypass.

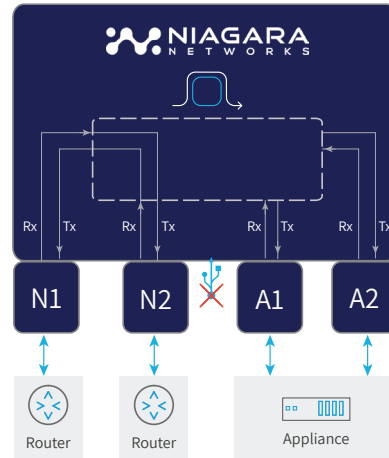

In case an external heartbeat is not received for the appropriate segment, and the count down timer for that segment expires, the affected segment will go into bypass mode.

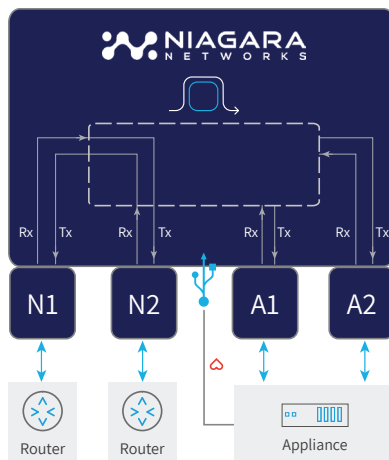
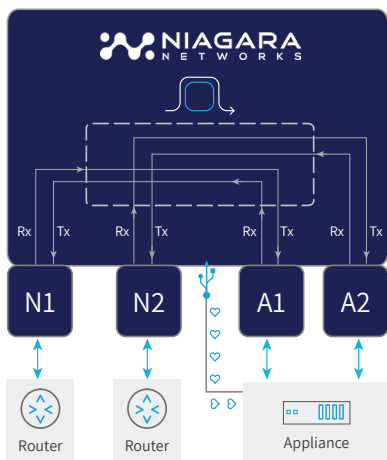

The appliance sends an external heartbeat via the USB port. As long as the heartbeat is received, the segment stays in normal mode and the appliance is inline with the network link. If the heartbeat is not received within the setup time, the segment will go into bypass, connecting the two network ports and bypassing the appliance.

Common Use Cases

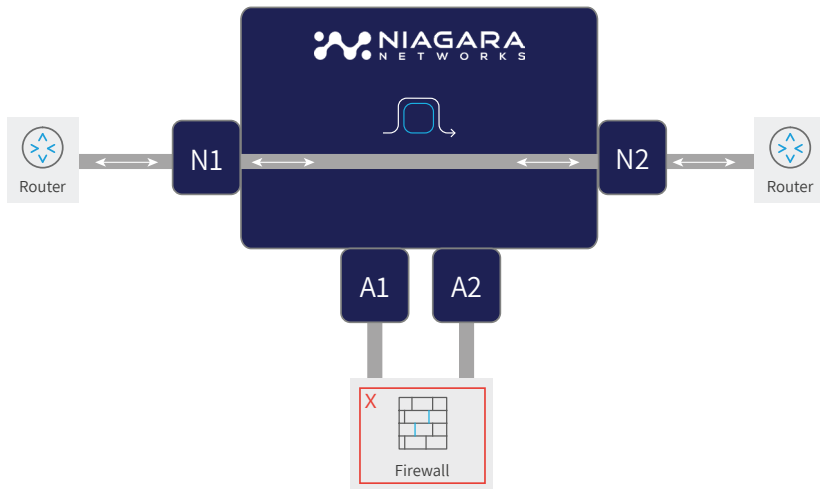

Protects network traffic in case of a security appliance failure.

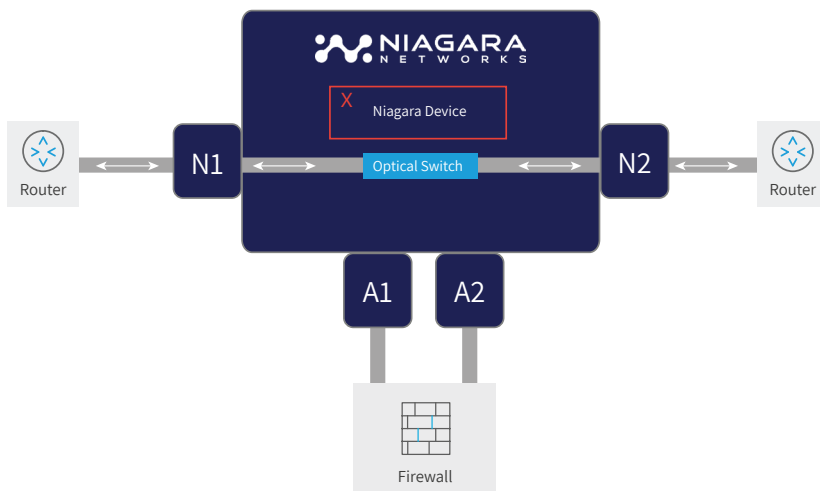

Supports high network availability. Traffic flow is maintained in case of failure of bypass switch

| Module Type | Insertion Loss (max.) | Failover Time (max.) |
|----------------------|-----------------------|----------------------|
| LC Fiber (MM and SM) | 2 dB | 8 ms |
| MPO Fiber (MM) | 3 dB | 8 ms |
| 1G Copper | 2.25 dB | 4 ms |
| 10G Copper | 2.29 dB | 10 ms |

Specifications

| | | | |
|--------------------|-------------------------------------|-----------|-----------------|
| Height | 1.75 in (44.5mm) | BTU/hr | 8.53 |
| Length | 10.07 in (256.0mm) | Fan-less | Passive cooling |
| Width | 17.33 in (440.0mm) | Altitude | 15,000 ft |
| Weight | 8.8 lb (3.39 kg) [fully configured] | Max Power | 2.5 Watts |
| Operating Temp | 32-104°F (0-40 °C) | DC | 5V DC USB |
| Operating Humidity | 5-95% RH, non-condensing | | |

Safety

Certifications

UL/CSA 60950-1, EN 60950-1, IEC 60950-1
CB Scheme with all country differences

North America (NRTL)
European Union (EU)
VCCI (Japan)

2014/35/EU Low Voltage Directive
2014/30/EU EMC Directive
2011/65/EU RoHS Directive
2012/19/EU WEEE Directive

Part Number

Description

| | |
|-------------------|--|
| 3296-MN | 3296 main chassis. USB power input. Supports up to 4 modules |
| 3296-SG-1TX-2B | 2 bypass segments of 1G Base-T. Each segment includes 2 network ports and 2 appliance ports |
| 3296-SG-10TX-2B | 2 bypass segments of 10G Base-T. Each segment includes 2 network ports and 2 appliance ports |
| 3296-SG-MM-2B | 2 passive bypass segments SR/SX 50/125. Each segment includes 2 network ports and 2 appliance ports. 1G/10G/25G/40G/100G/BiDi/SWDM4 |
| 3296-SG-MM5-2B | 2 bypass segments SR/SX 62.5/125. Each segment includes 2 network ports and 2 appliance ports. Supports 1/10Gb multimode links |
| 3296-SG-SM-2B | 2 passive bypass segments LR4/LR/LX. Each segment includes 2 network ports and 2 appliance ports 1G/10G/25G/40G/100G |
| 3296-SG-MM-MPO-1B | 1 bypass segment SR4 MPO. Segment includes 2 network ports and 2 appliance ports. Supports 40/100Gb multimode links |

About Niagara Networks

Niagara Networks provides high performance network visibility solutions for seamless administration of security solutions, performance management and network monitoring. Niagara Networks products provide advantages in terms of network operation expenses, downtime, and total cost of ownership. A former division of Interface Masters, Niagara Networks provides all the building blocks for an advanced Visibility Adaptation Layer at all data rates up to 100Gb, including TAPs, bypass elements, packet brokers and a unified management layer. Thanks to its integrated in-house capabilities and tailor-made development cycle, Niagara Networks is agile in responding to market trends and in meeting the customized needs of service providers, enterprises, data centers, and government agencies. For more information please visit us at www.niagaranetworks.com

Copyright ©10/ 2020 Niagara Networks™. All rights reserved. Product specifications are subject to change without notice or obligation